

A B p 9-1 A X B 9-2

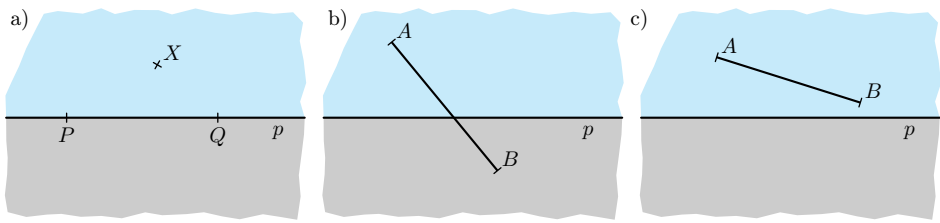

9-3abc

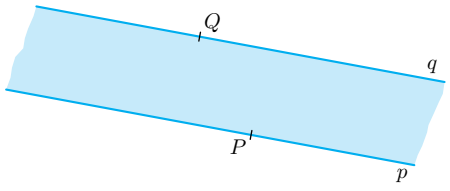

9-4

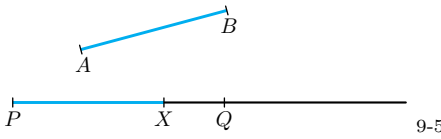

9-5

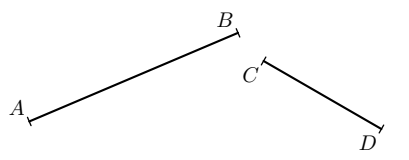

9-6

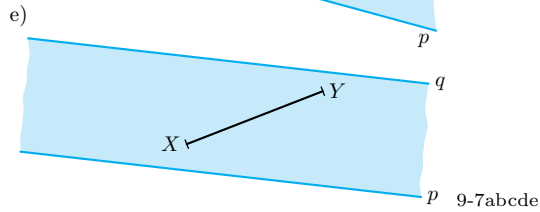
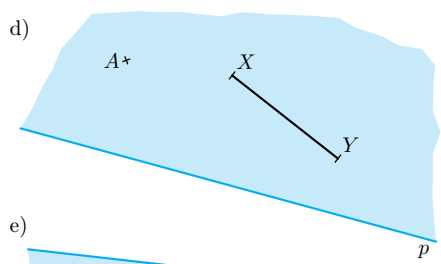
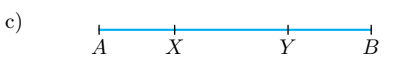
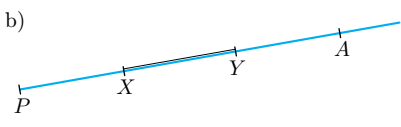
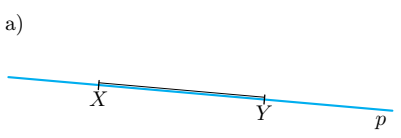

9-7abcde

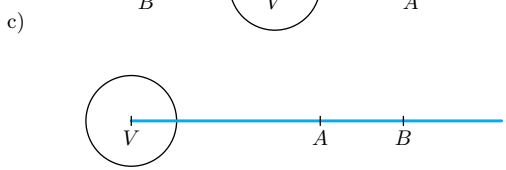
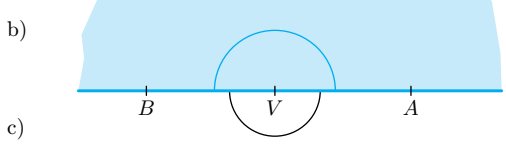
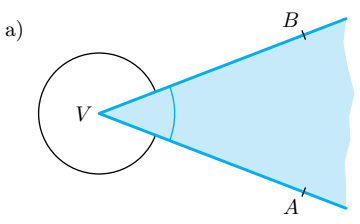

9-8abc

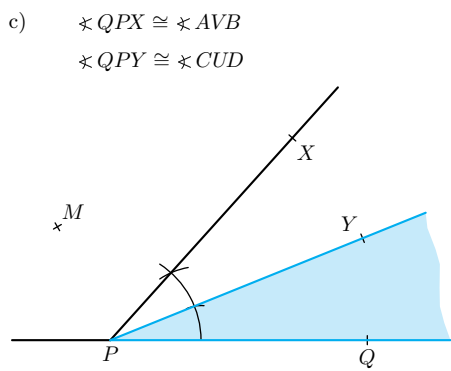
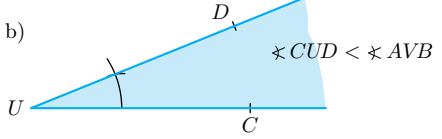
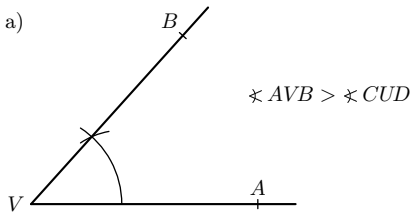

9-9abc

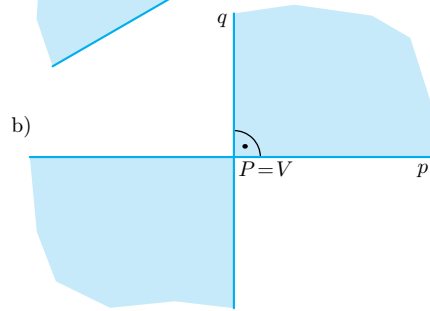
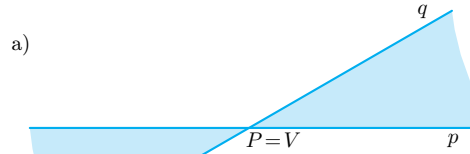
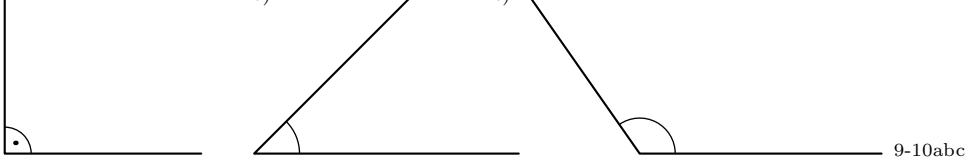

9-13ab

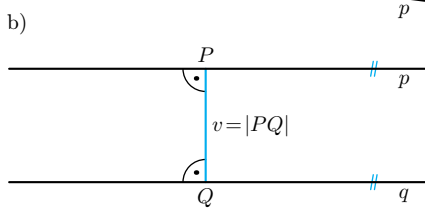
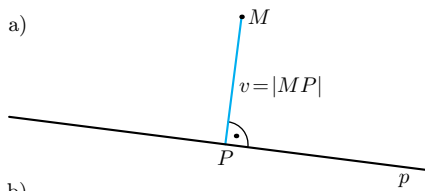
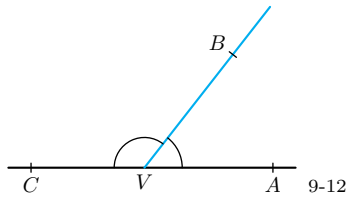
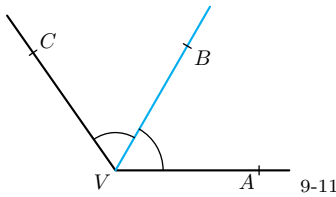

9-14ab

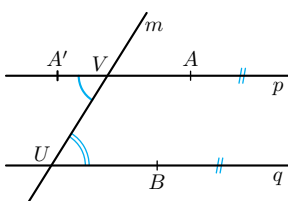
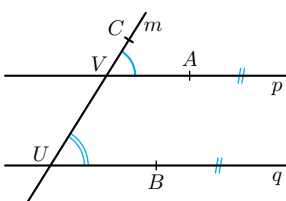
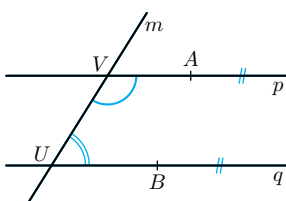
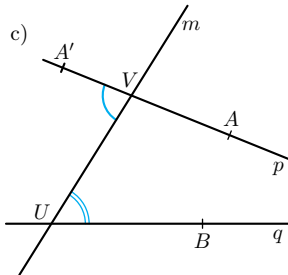
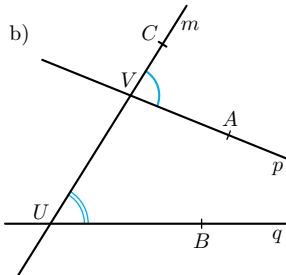
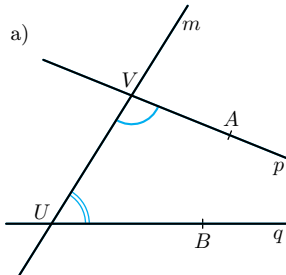

9-15abc

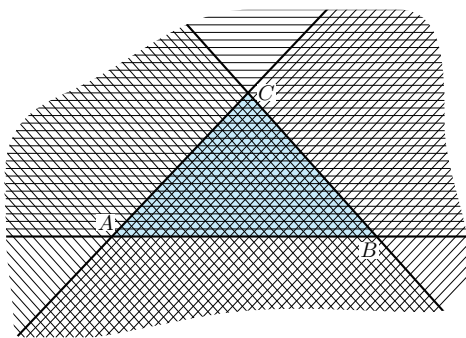

9-16

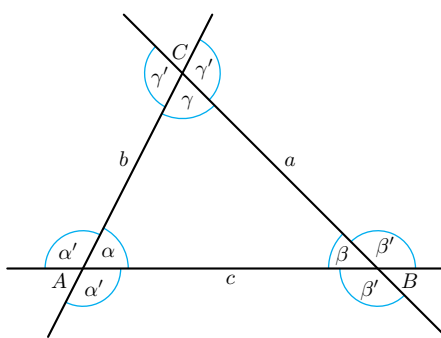

9-17

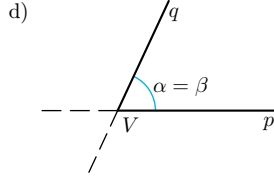
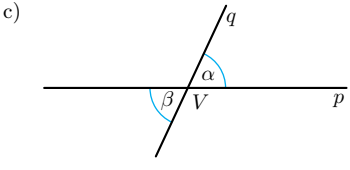
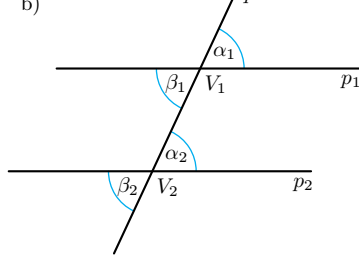
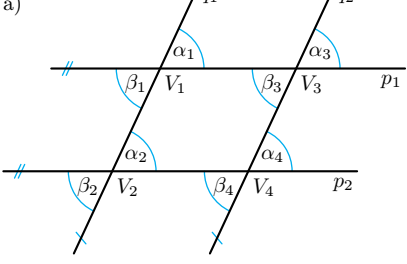

9-18abcd

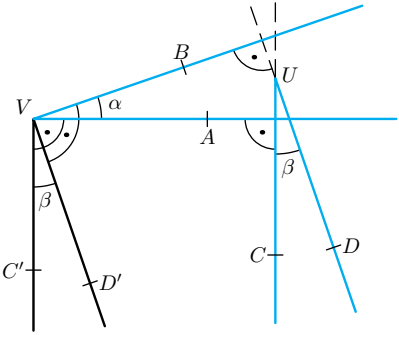

9-19

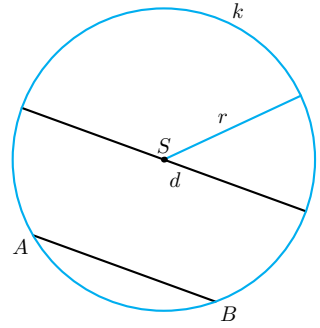

9-20

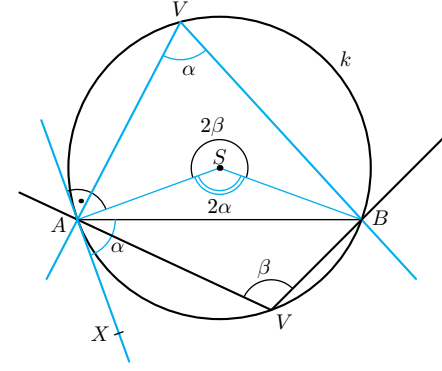

9-21

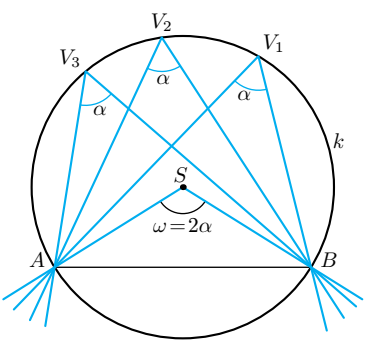

9-22

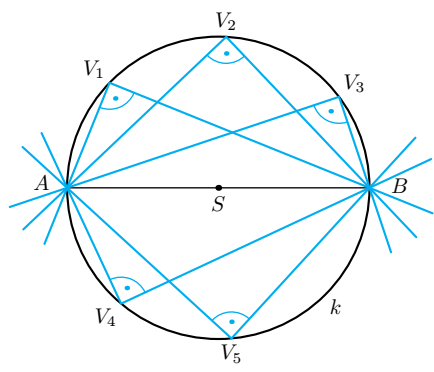

9-23

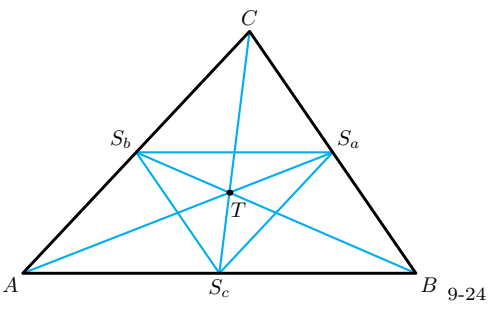

9-24

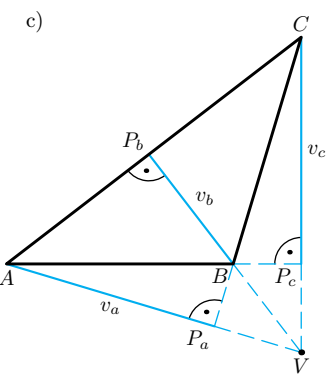
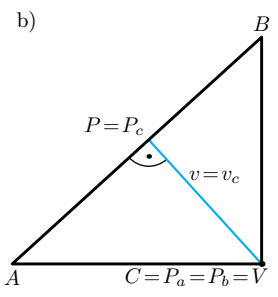
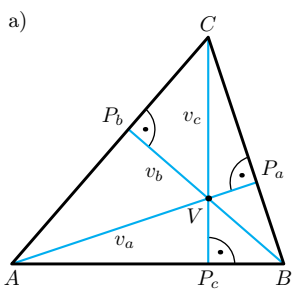

9-25abc

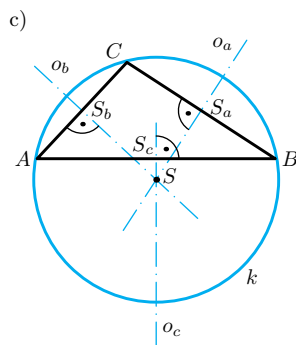
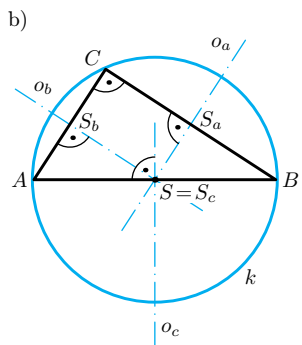
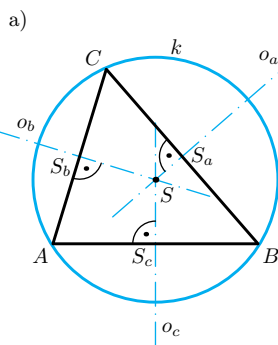
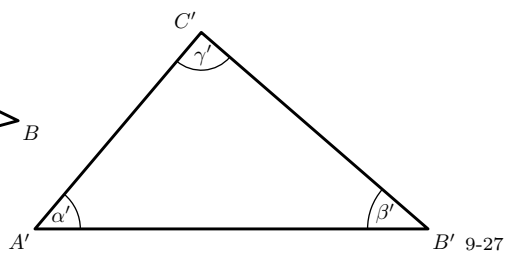
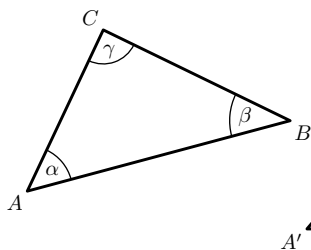
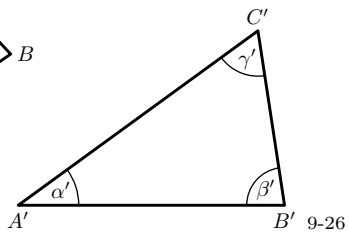
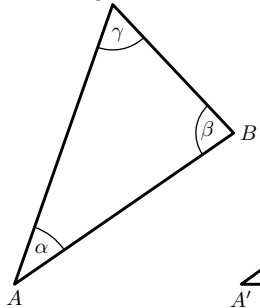

9-28abc

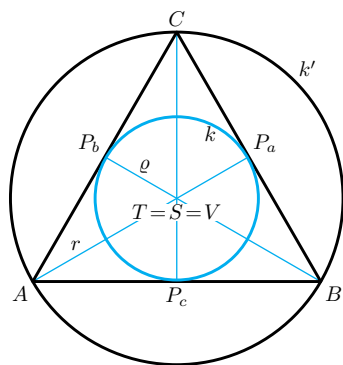
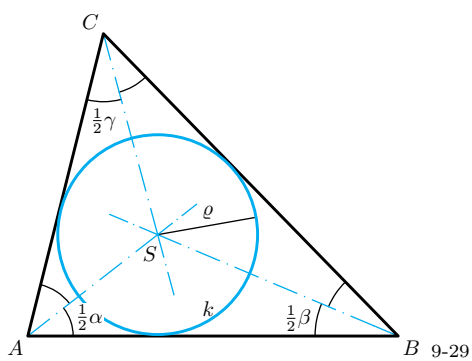

9-30

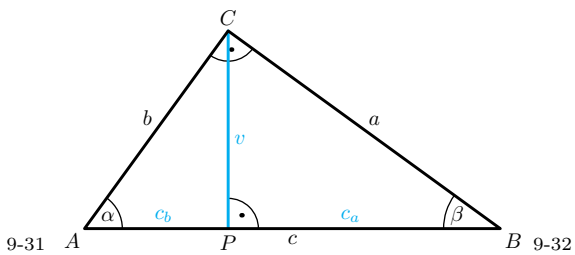
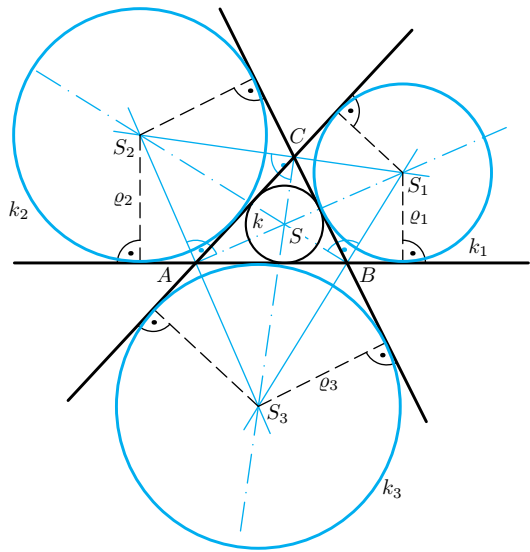

9-31

9-32

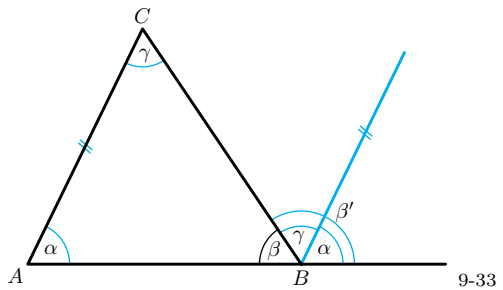

9-33

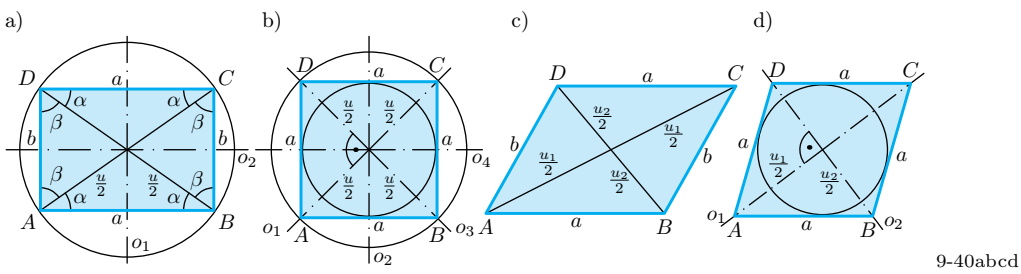
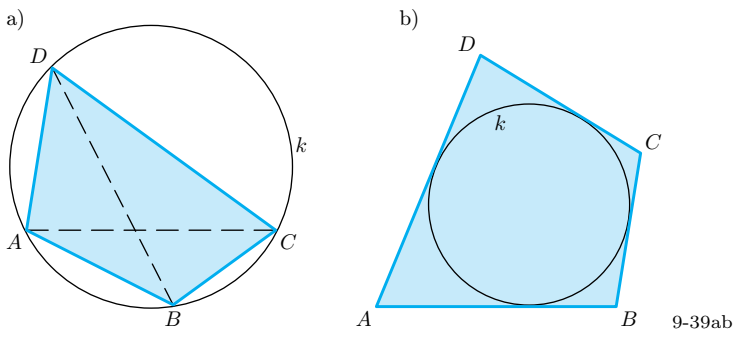
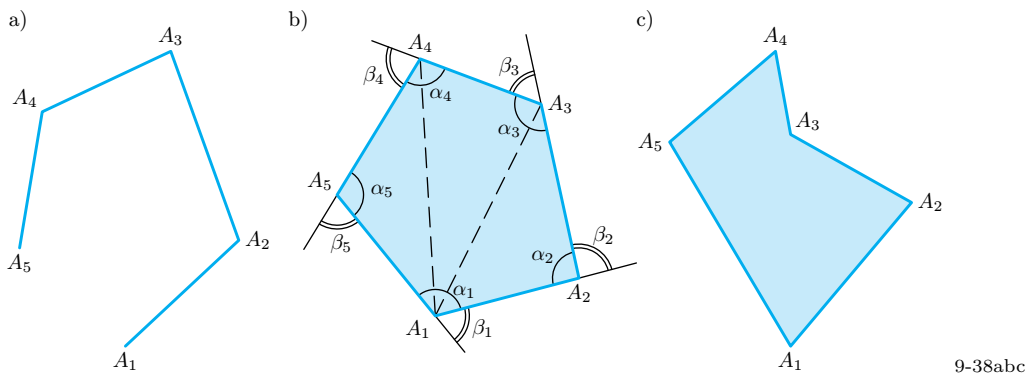
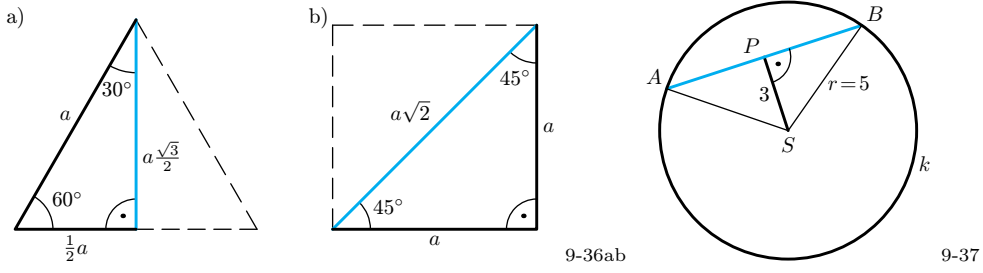
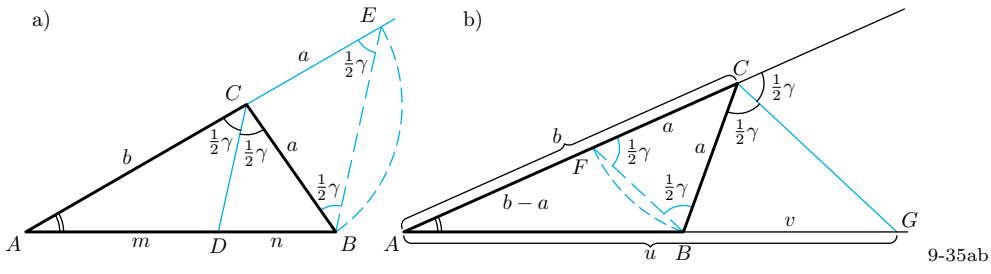
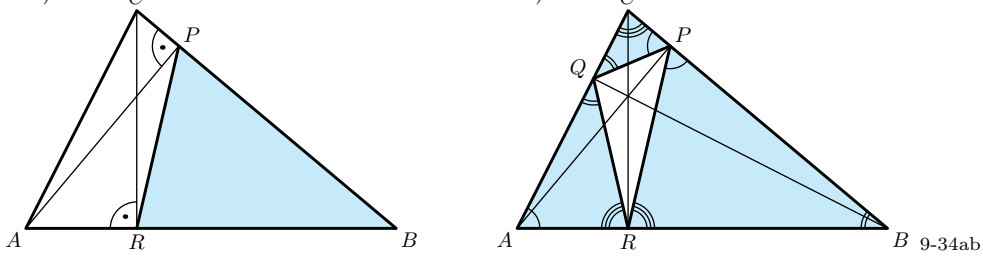

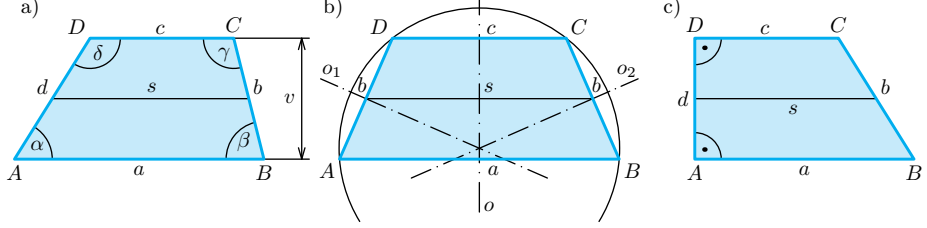

9-41abc

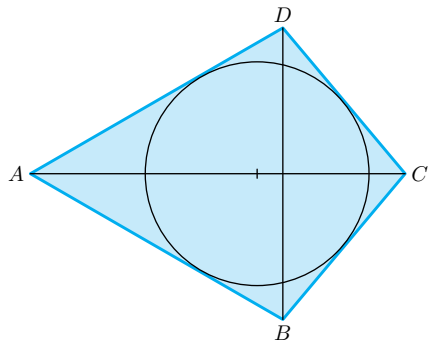

9-42

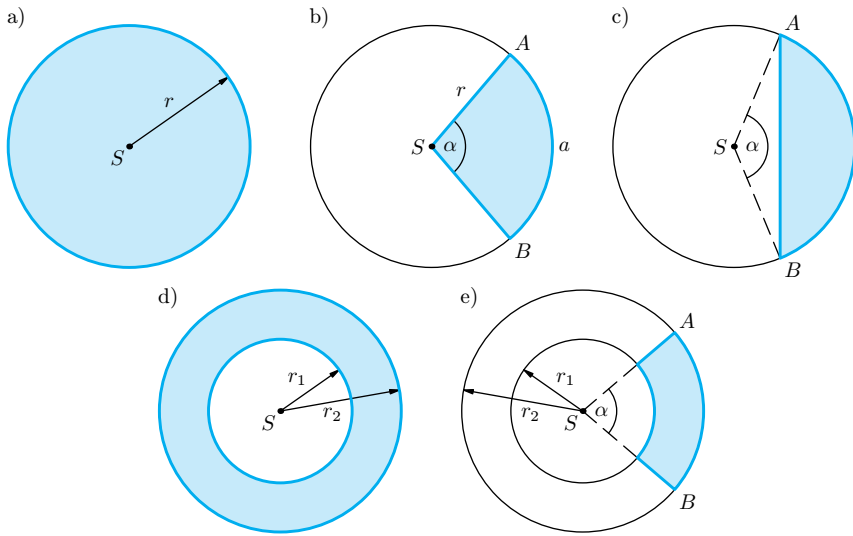

9-43abcd

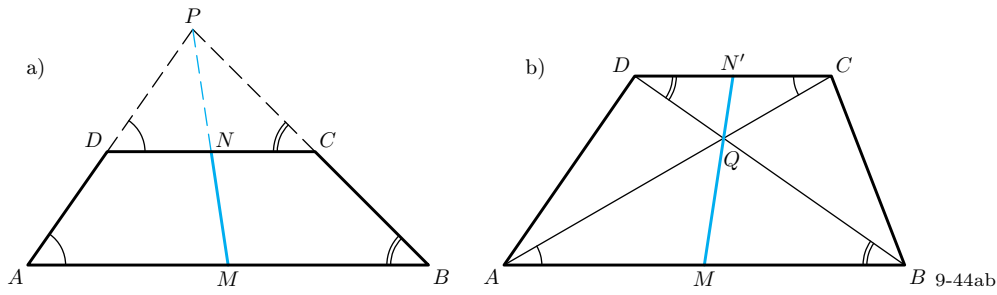

9-44ab

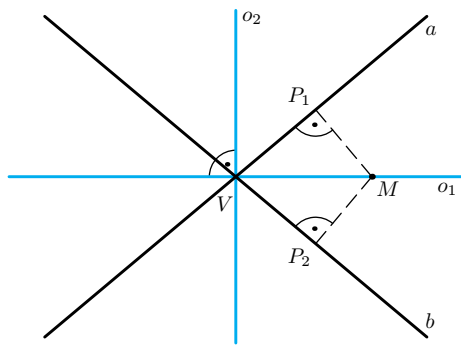

9-45

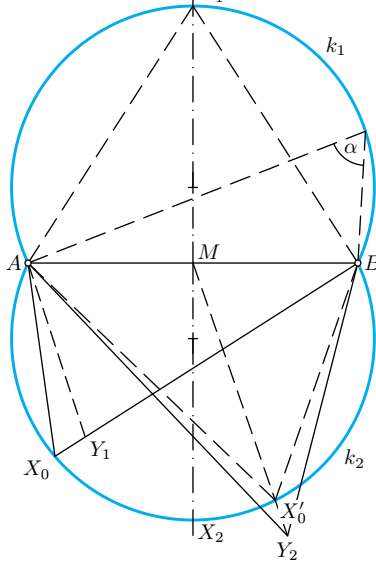

9-46

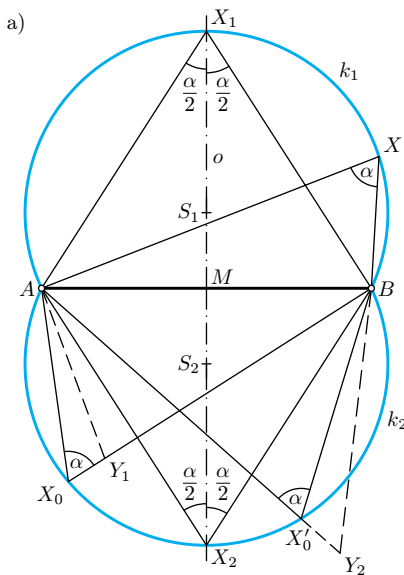

b)

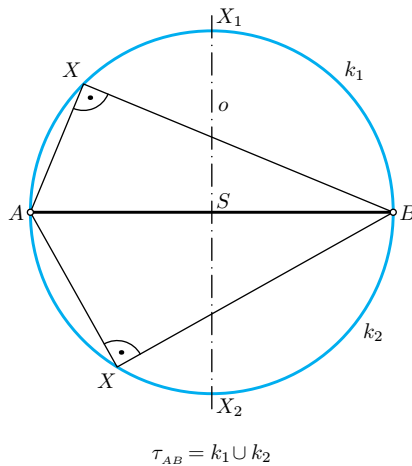

$$\tau_{AB} = k_1 \cup k_2$$

9-46ab

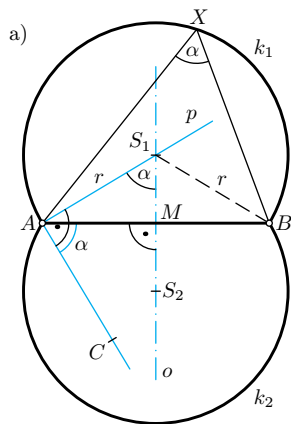

b)

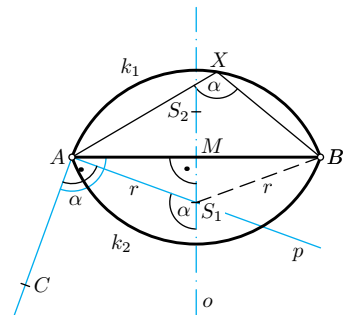

9-47ab

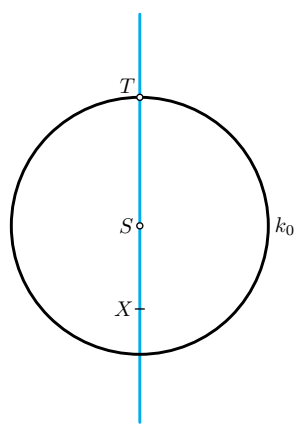

9-48

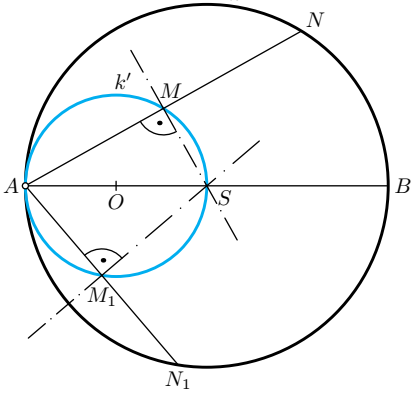

9-49

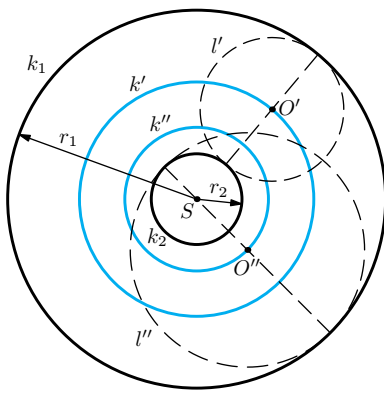

9-50

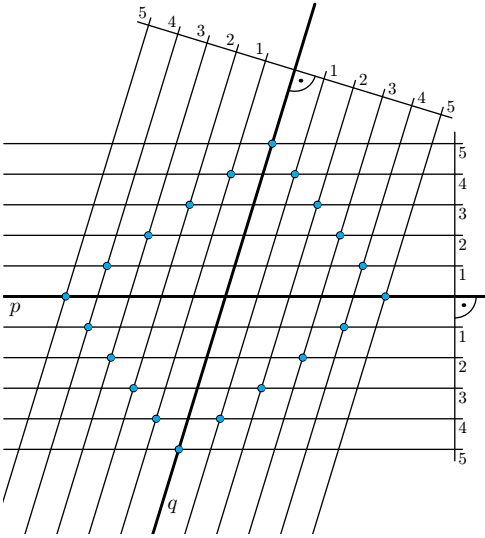

9-51

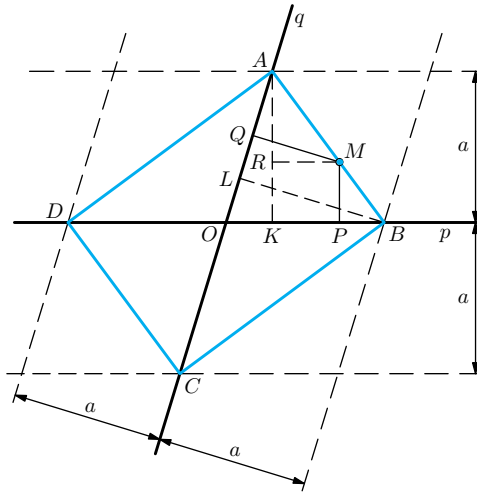

9-52

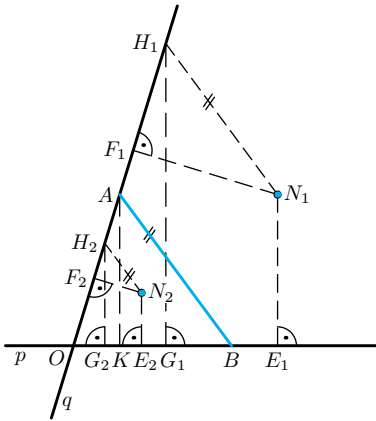

9-53

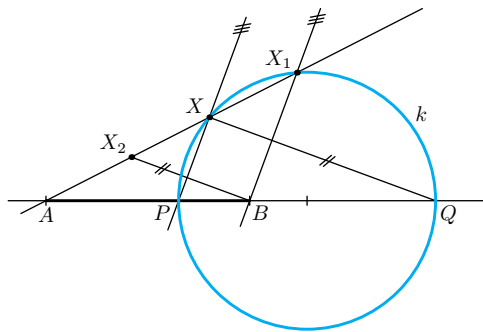

9-54

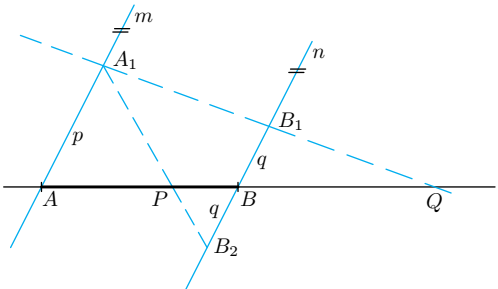

9-55



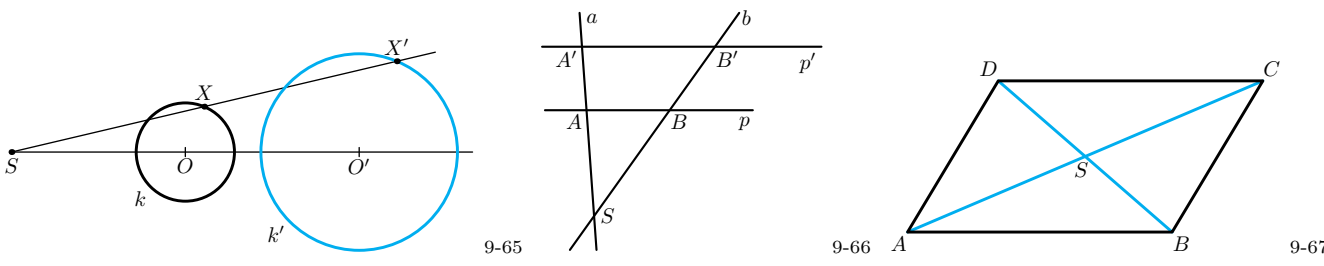
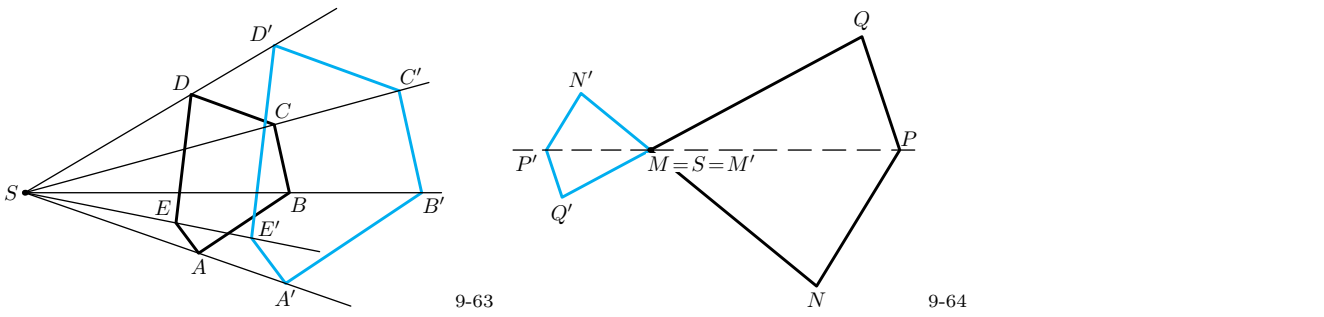
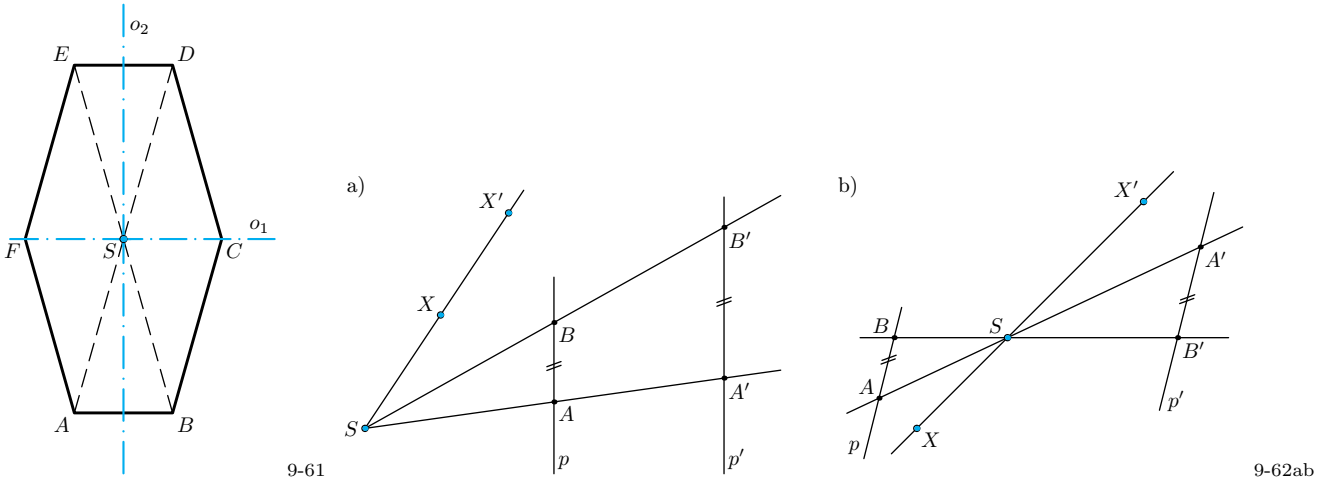
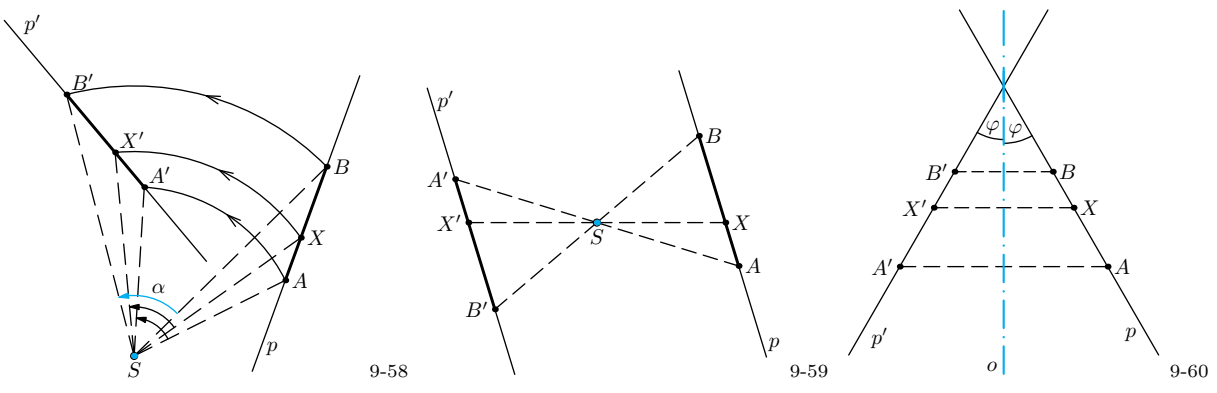
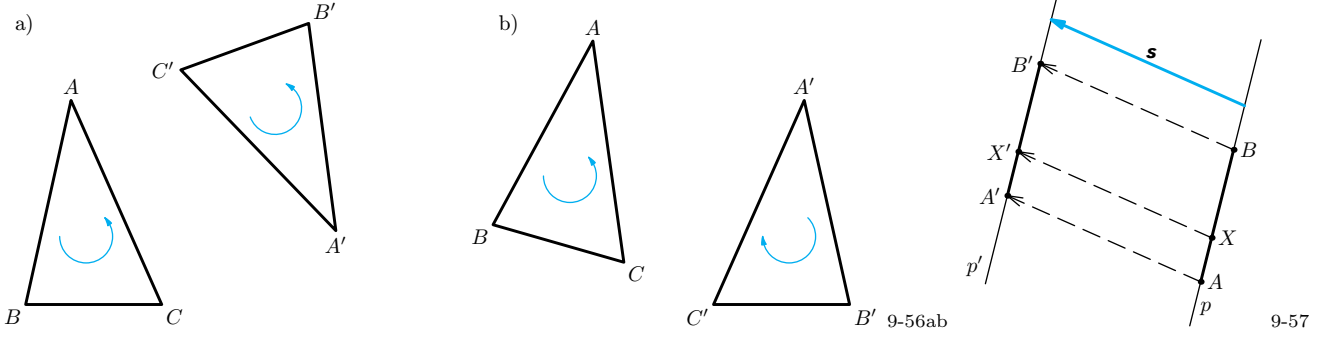

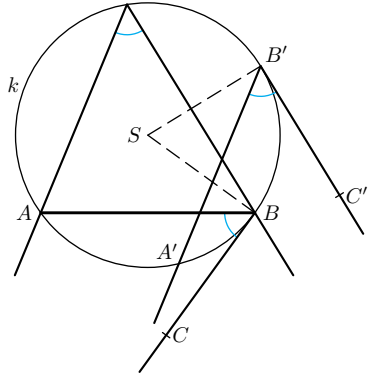

9-68

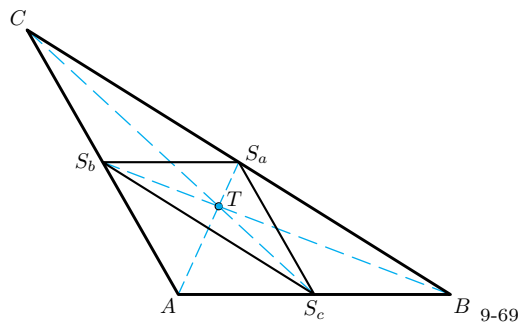

9-69

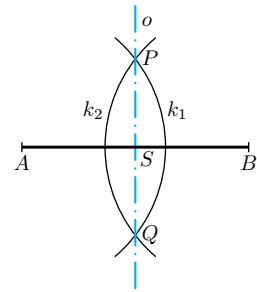

9-70

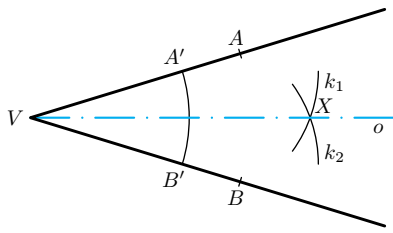

9-71

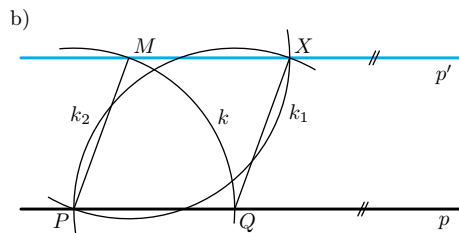
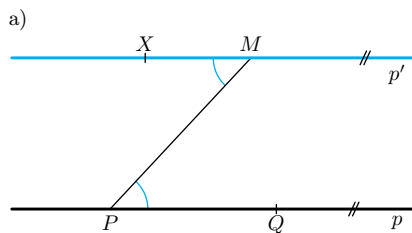

9-72ab

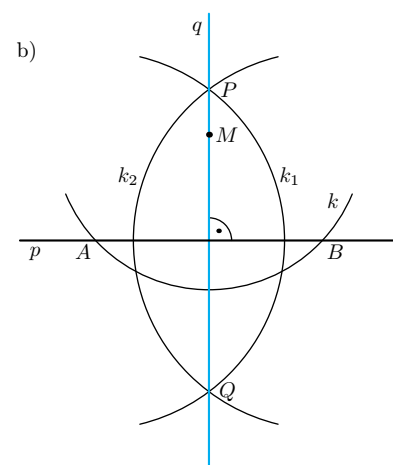
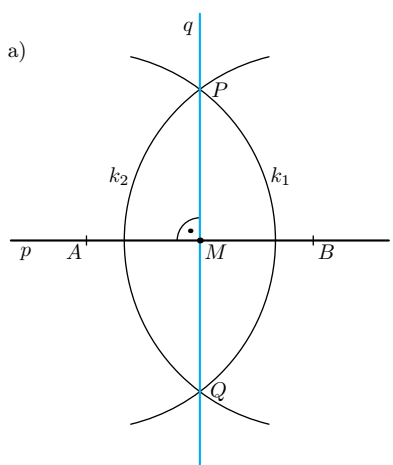

9-73ab

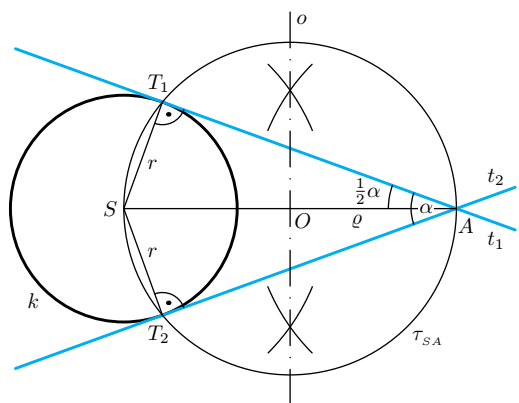

9-74

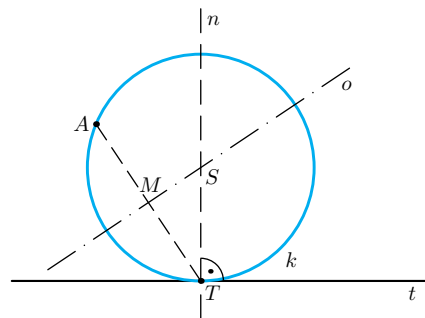

9-75

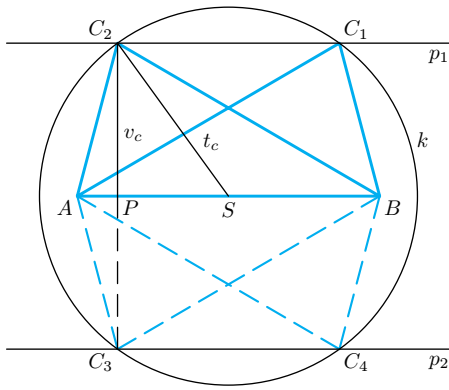

9-76

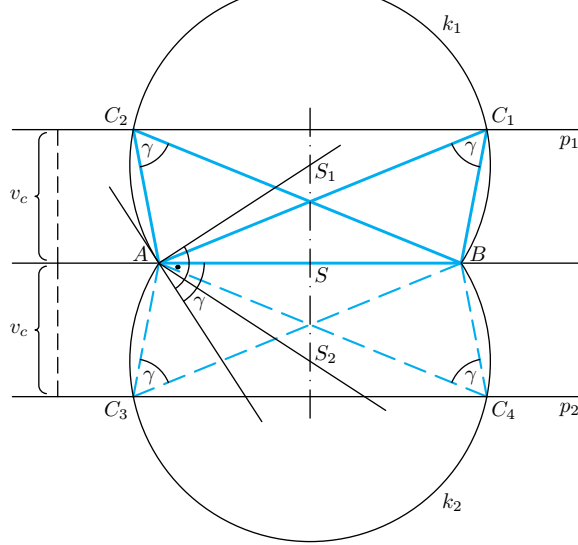

9-77

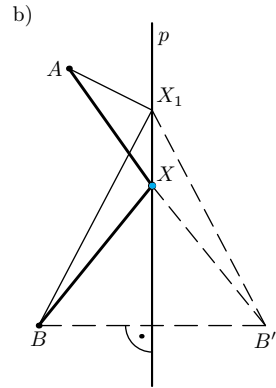
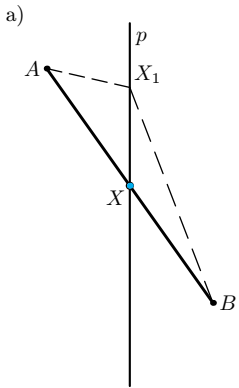

9-78ab

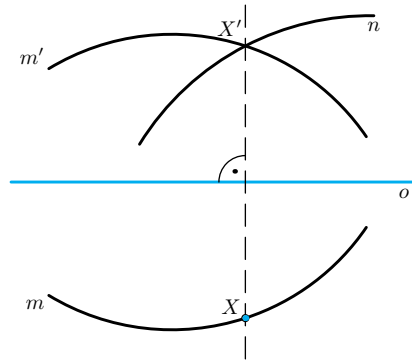

9-79

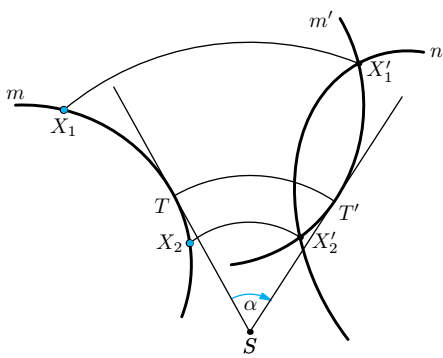

9-80

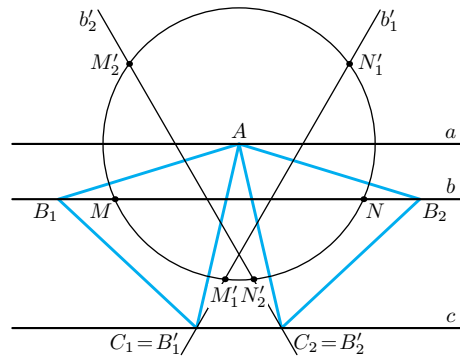

9-81

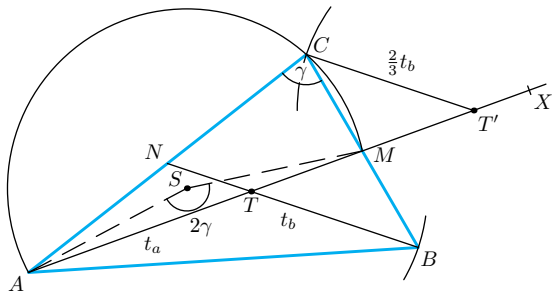

9-82

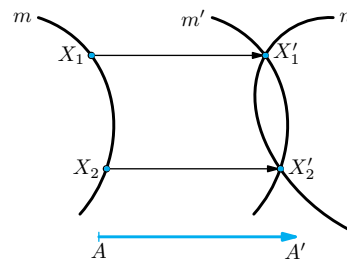

9-83

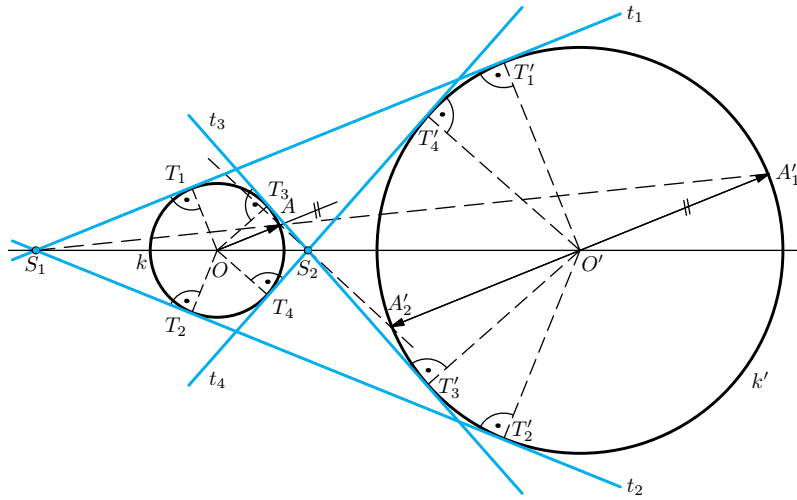
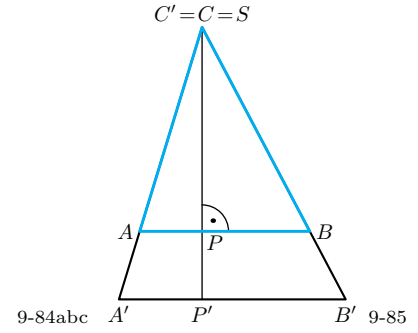
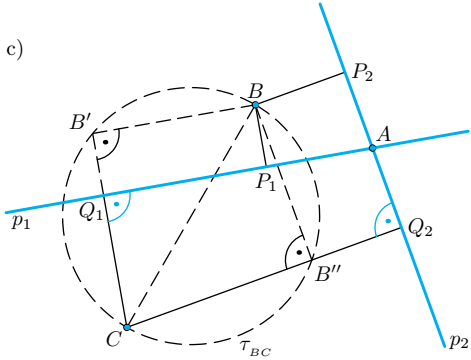
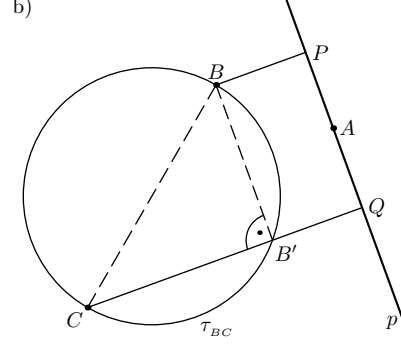
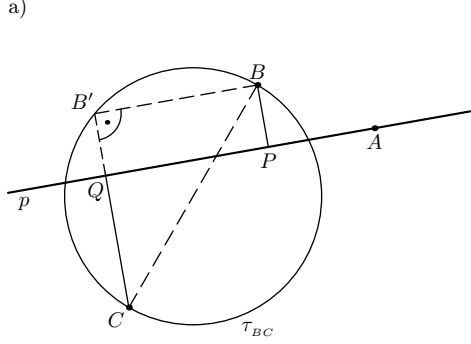

9-86

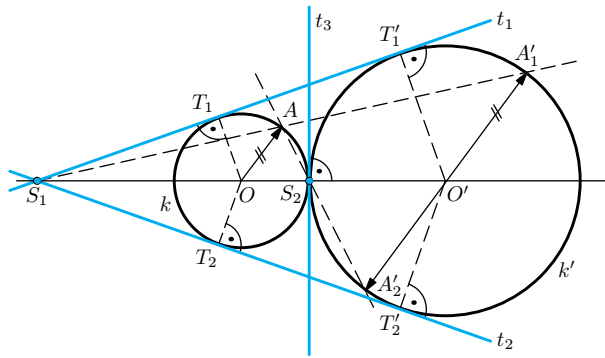

9-87

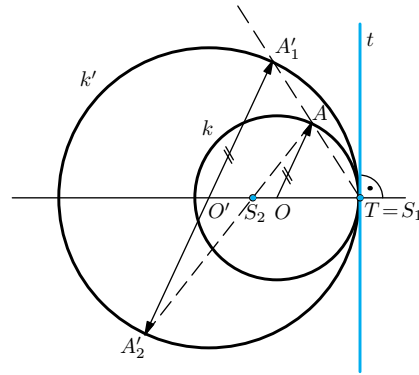

9-88

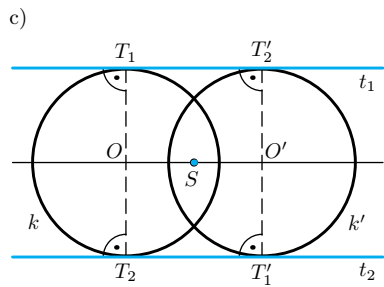
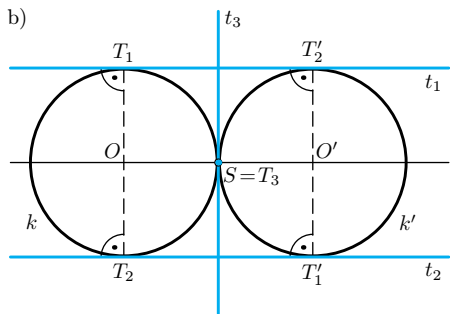
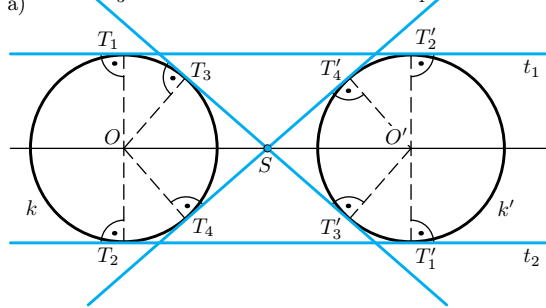

9-89abc

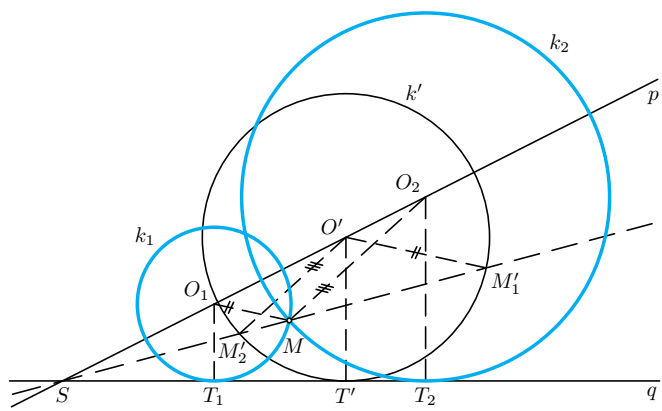

9-90

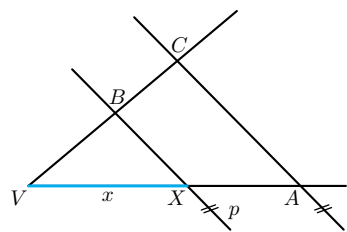

9-91

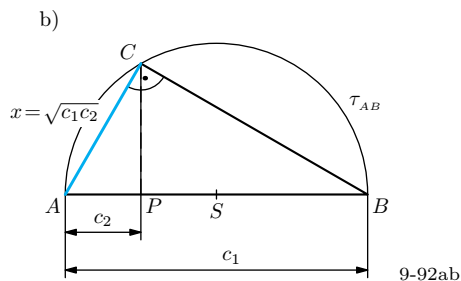
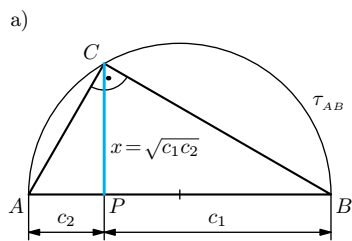

9-92ab

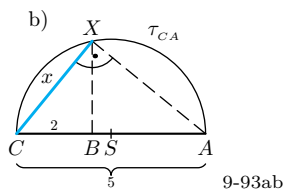
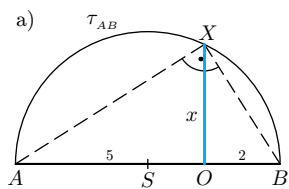

9-93ab

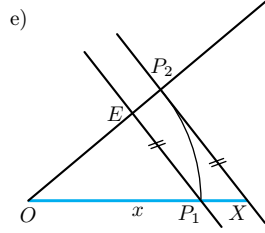
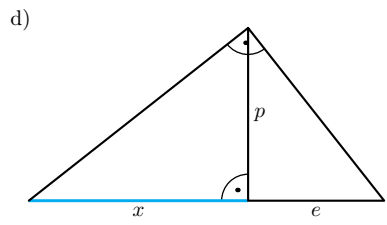
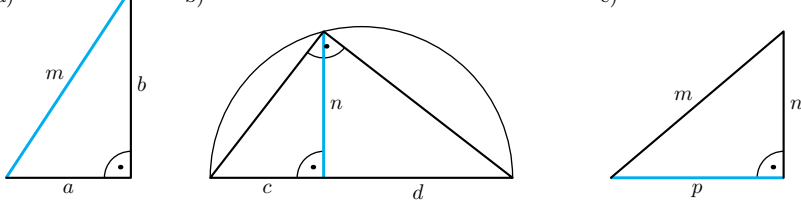

9-94abcd

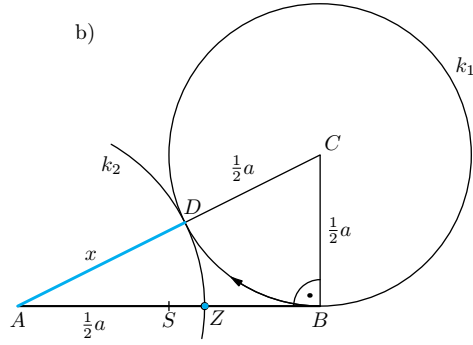
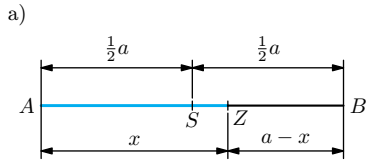

9-95ab

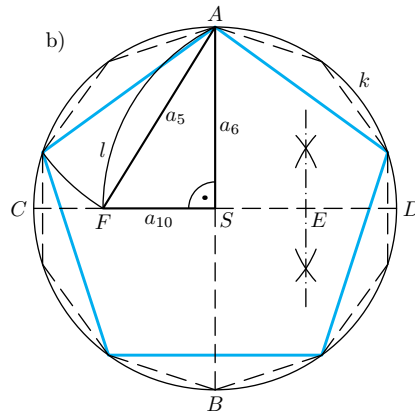
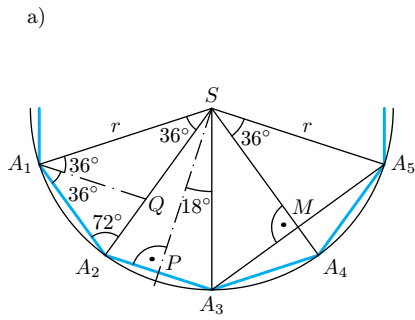

9-96ab

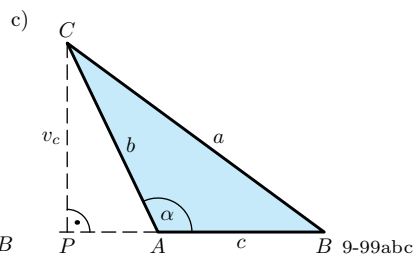
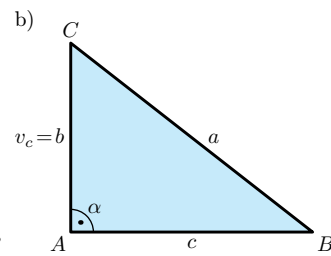
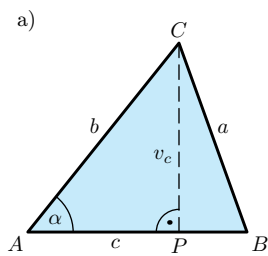
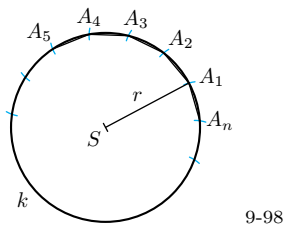
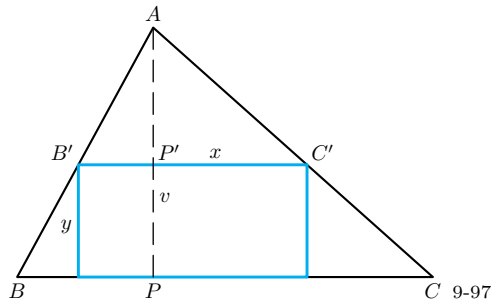

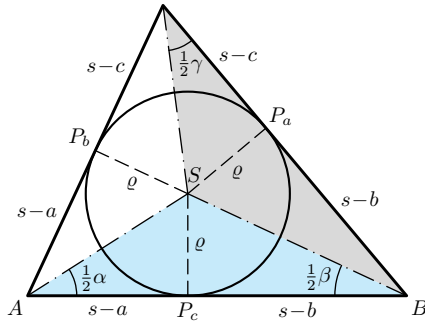

9-100

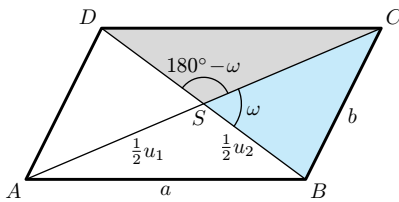

9-101

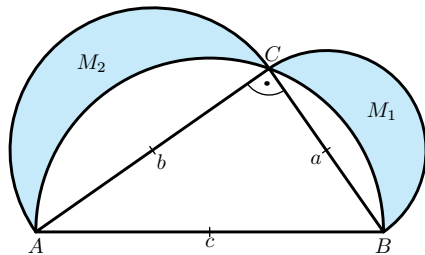

9-102

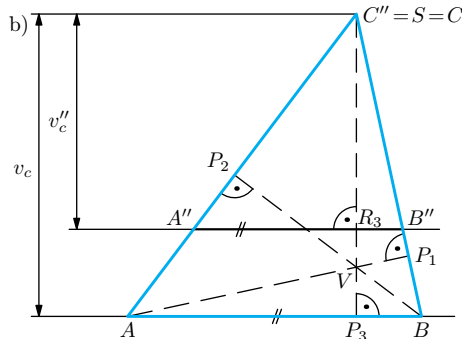
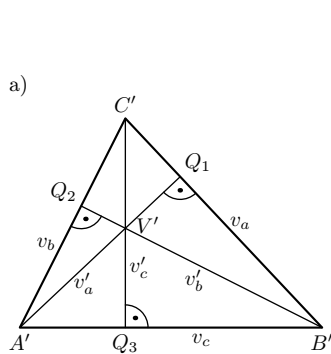

9-103ab

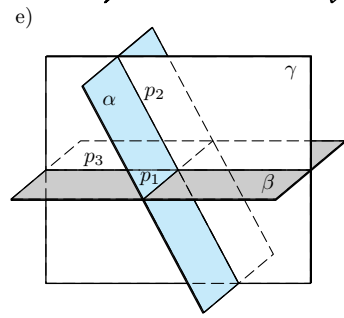
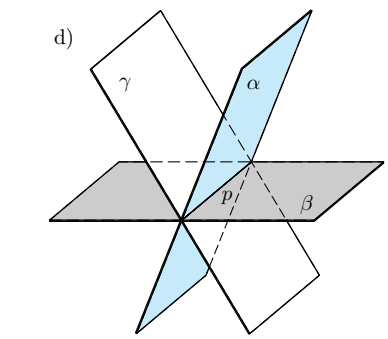
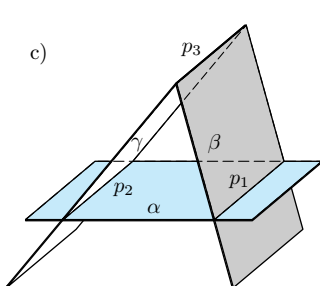
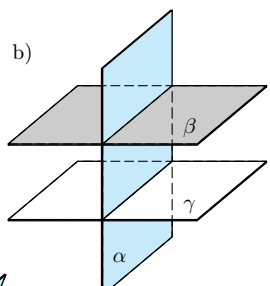
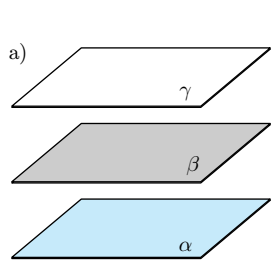

9-104abc

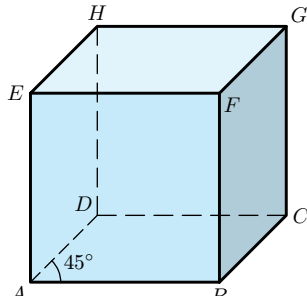

9-105

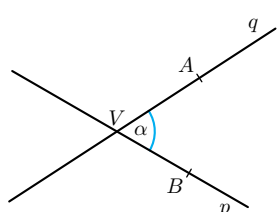

9-106

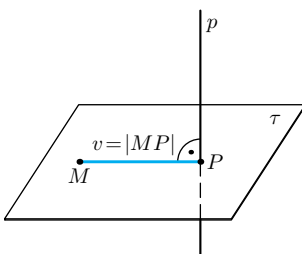

9-107

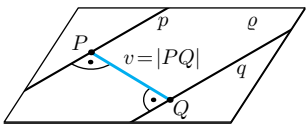

9-108

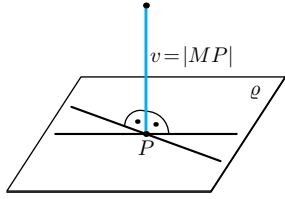

9-109

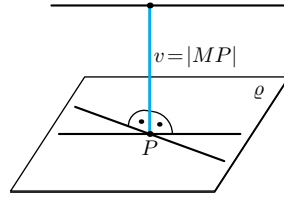

9-110

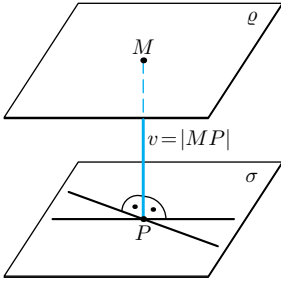

9-111

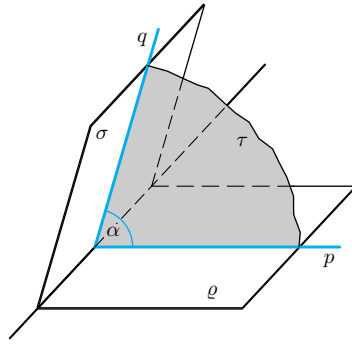

9-112

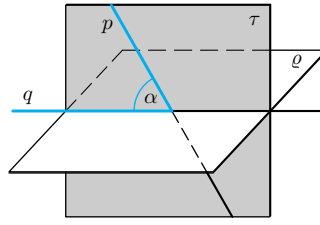

9-113

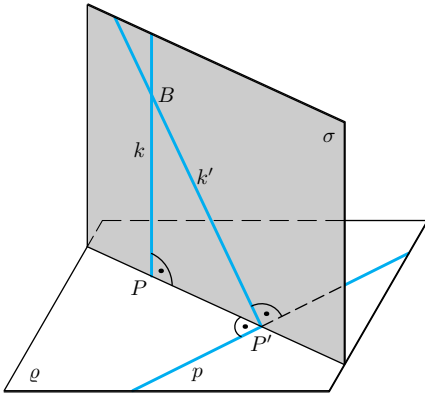

9-114

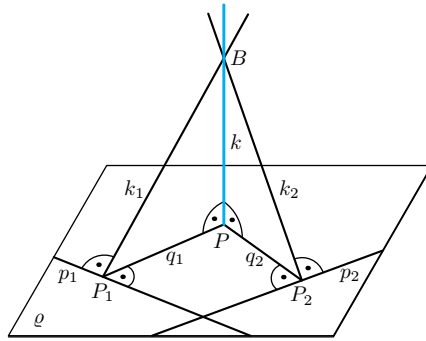

9-115

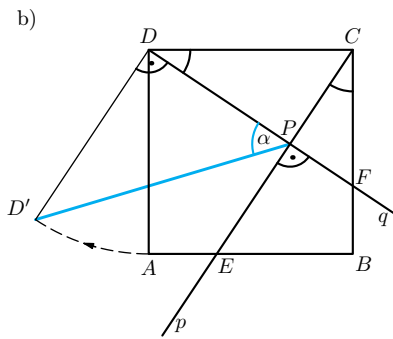
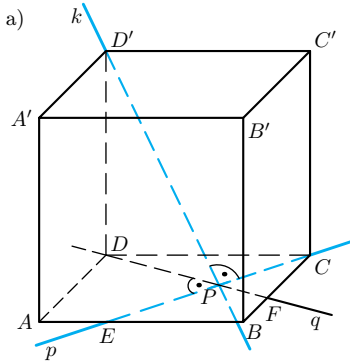

9-116ab

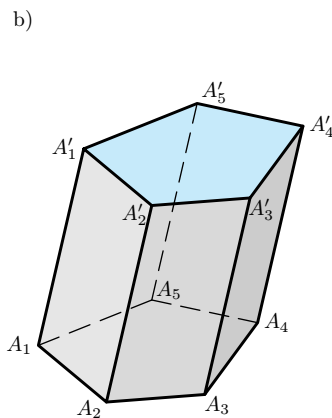
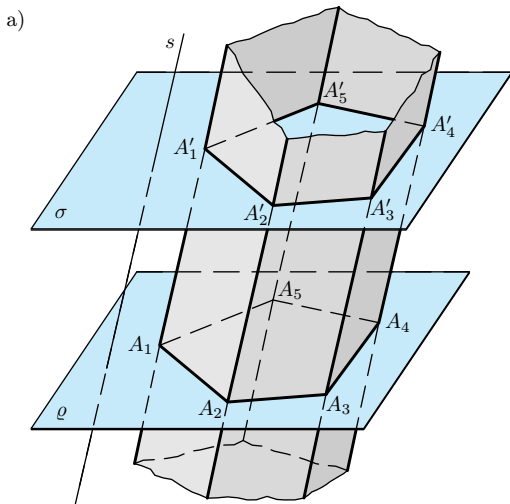

9-117ab



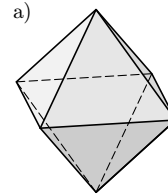
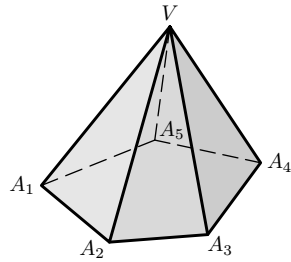
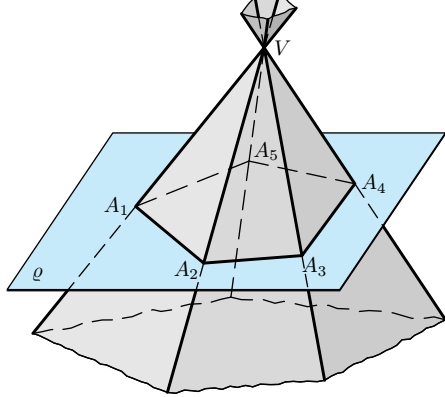

9-118ab

9-119a

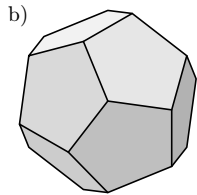

9-119b

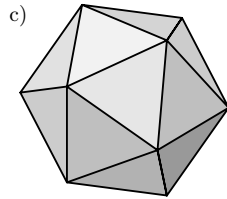

9-119c

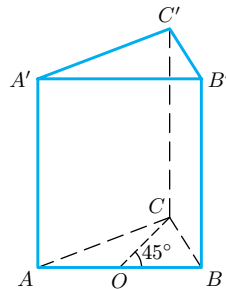

9-120

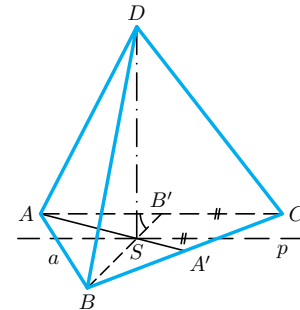

9-121

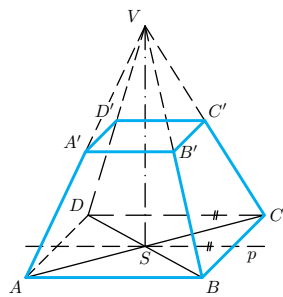

9-122

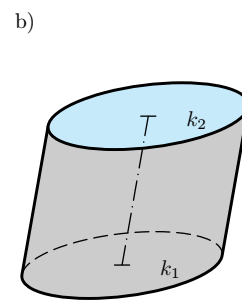
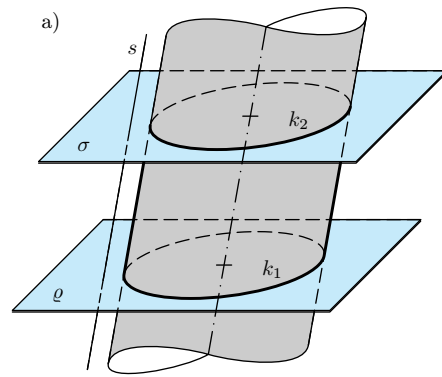

9-123ab

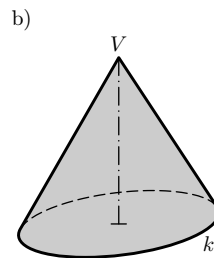
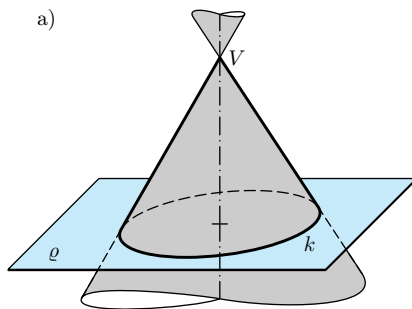

9-124ab

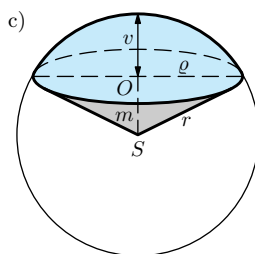
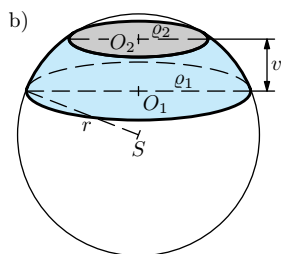
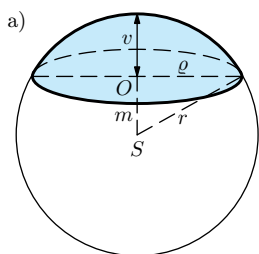

9-125abc

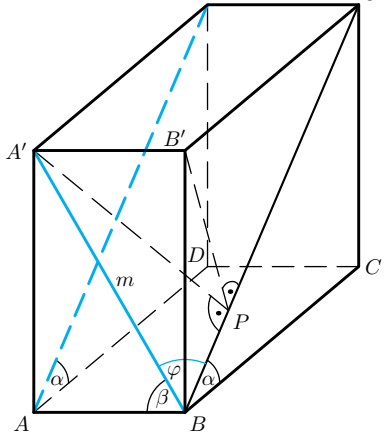

9-126

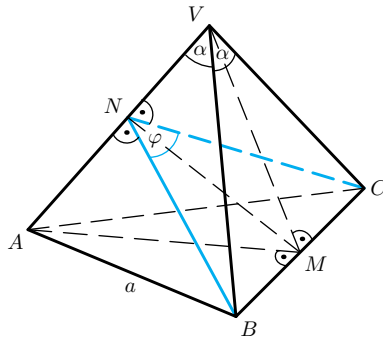

9-127

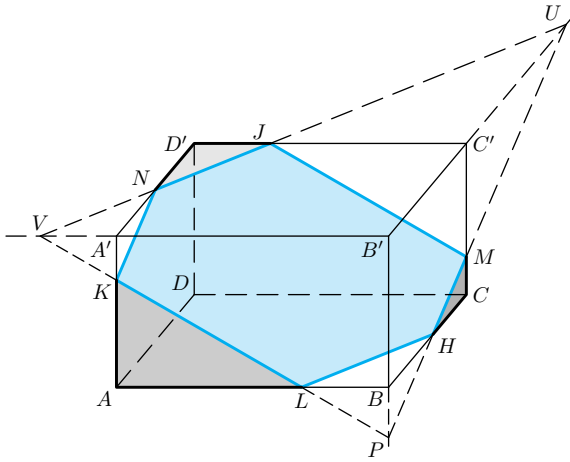

9-128

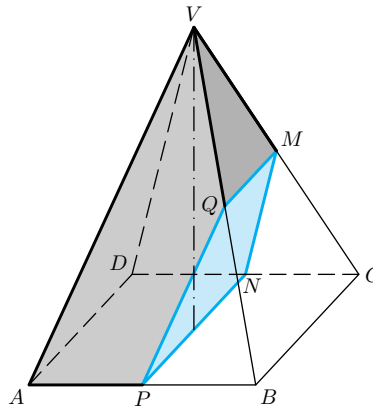

9-129

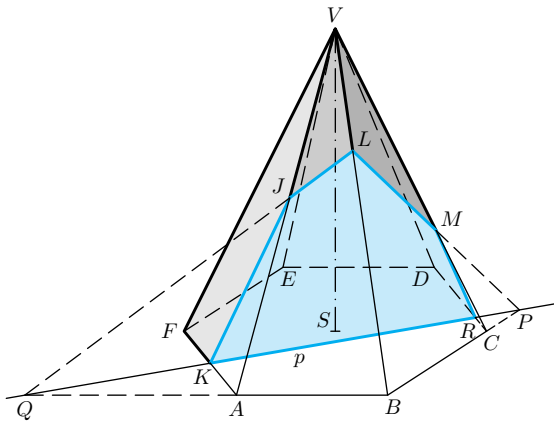

9-130

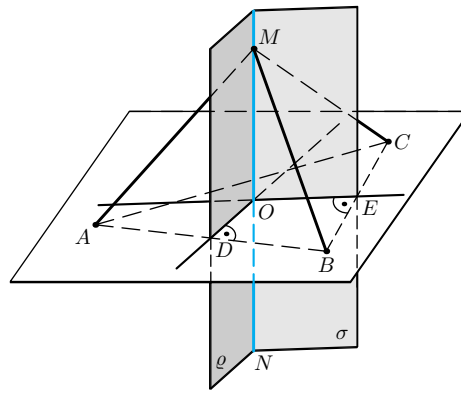

9-131

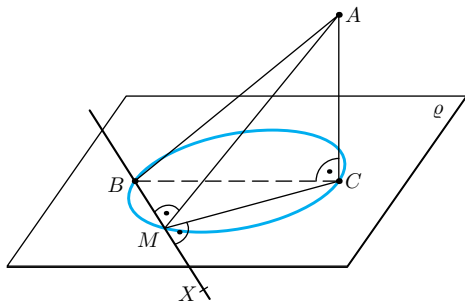

9-132

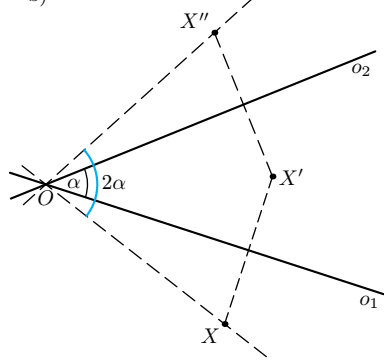
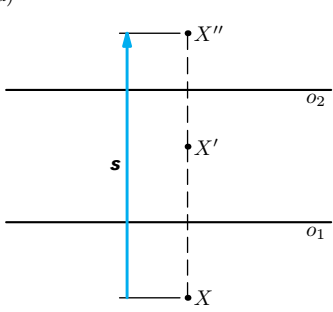

9-133ab

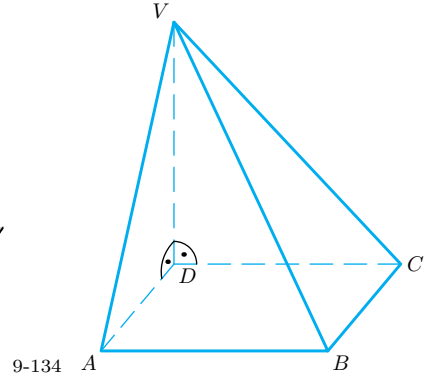
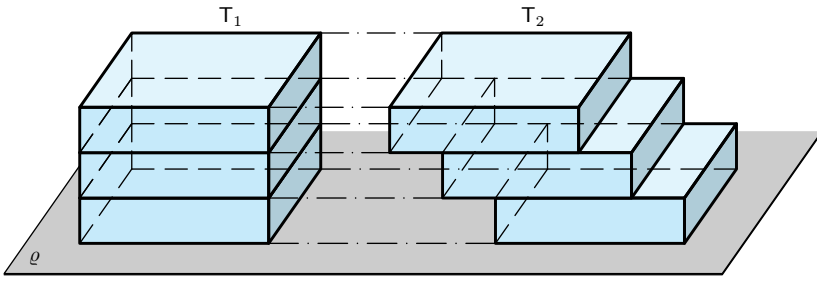

9-134

9-135

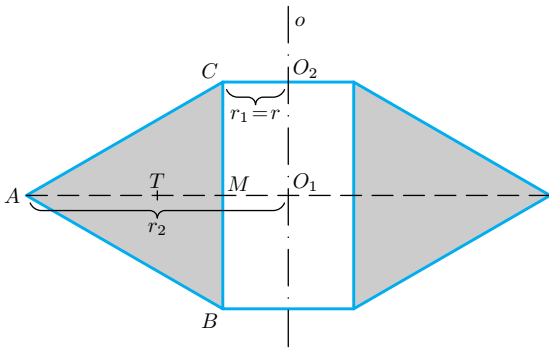

9-136

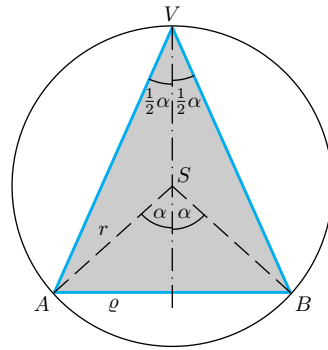

9-137

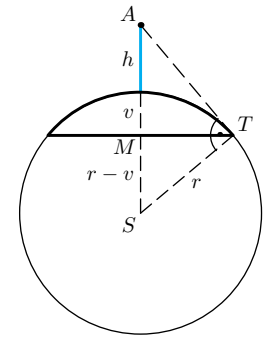

9-138